

STAGE 3

ITEMS REQUIRED: Base / cabinet body / 4 locking screws / 4 locking nuts / 4 feet / 4 medium screws

There are 4 plastic white holes on both sides of the base, the closest are for the locking screws and the furthest apart are for the feet. Locate the feet with medium screws and screw in the locking screws. Ensure the main cabinet body you have constructed is upside down (the door handles are at the bottom). Line up the screws in the base with the holes on the top edge of the sides and push together. Push the locking nuts into the side panels and lock the screws as in Fig. 2. Now rotate the stand so that it is standing on its feet.

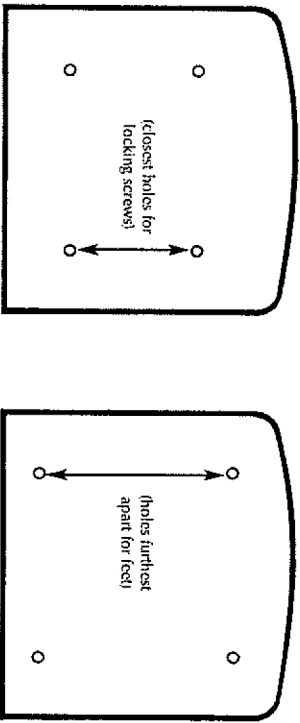

STAGE 4

ITEMS REQUIRED: Top / 4 locking screws / 4 locking nuts / shelf / 4 shelf supports / 1 damper / 2 small screws

Attach the damper where pilot holes are drilled (with push in damper pointing towards the curved front of the top) with two small screws.

Screw the 4 locking screws into the top and attach to cabinet body using the same method as used for the base.

Push the 4 shelf supports into the inside of the cabinet (you may need a mallet). Insert shelf.

CONSUMER ADVICE CONTACT DETAILS







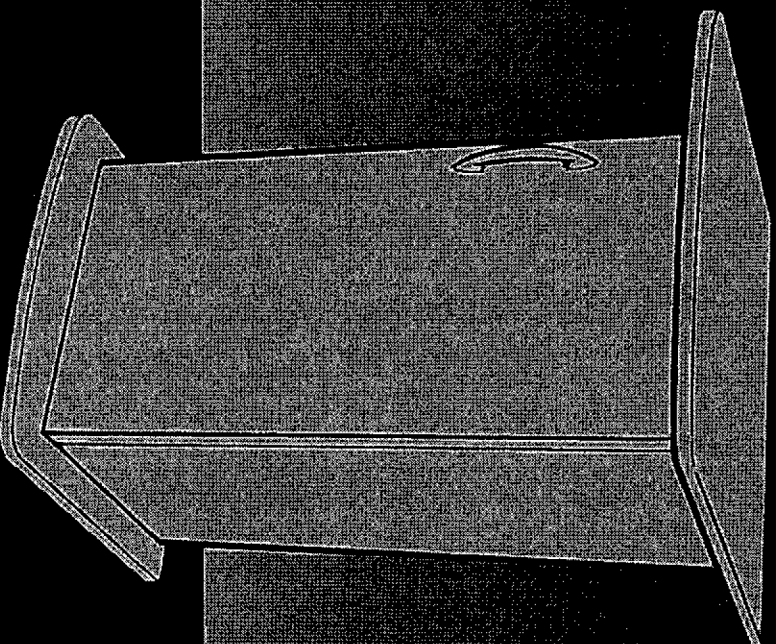

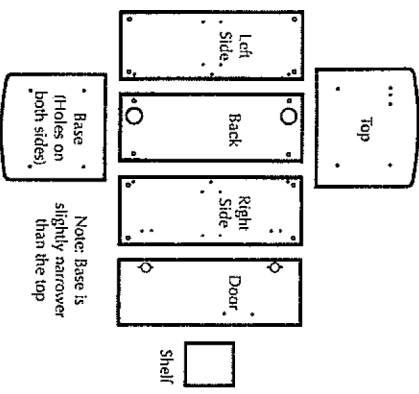

Interpet Consumer Advice Department
Vincent Lane, Dorking, Surrey, RH4 3YX
Telephone: 0845 226 7437 (Monday to Friday, 10am to 1pm except Bank Holidays)
Fax: 01306 876712
E-mail: customercare@interpet.co.uk



AQUARIUM 1 DOOR CABINET INSTRUCTIONS

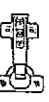

CONTENTS

12 x Locking Screws		
12 x Locking Nuts		
10 x Small Screws		
6 x Medium Screws		
4 x Shelf Supports		
2 x Dowels		
2 x Hinges		
1 x Handle		
4 x Feet		
1 x Door Damper		

ASSEMBLY DIAGRAM

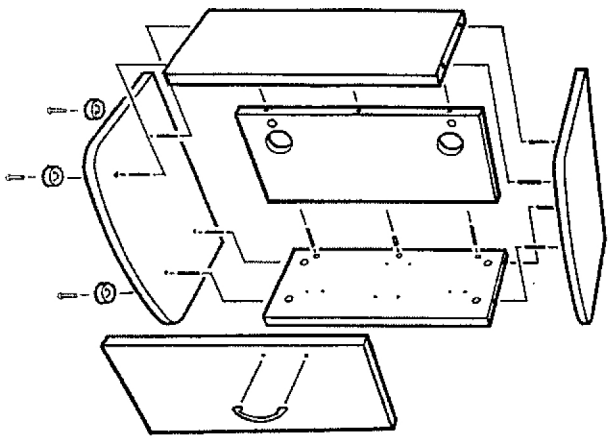

STAGE 1

ITEMS REQUIRED: Door / right side / 8 small screws / 2 medium screws / 2 x hinges

Place the right hand side and door together with holes uppermost on a flat surface. Place the hinges in the large holes in the door. Fix hinges to door with the small screws, using a cross head screwdriver.

Line up hinges with small holes in the side panel and fix in with the small screws (you may need to close the hinges to right angles to line up holes easily as shown in Fig. 1)

Fix handle to the door using two medium screws.

Once the cabinet is complete you may need to adjust the screws in the hinges to ensure there is an even gap between the doors and the side panels.

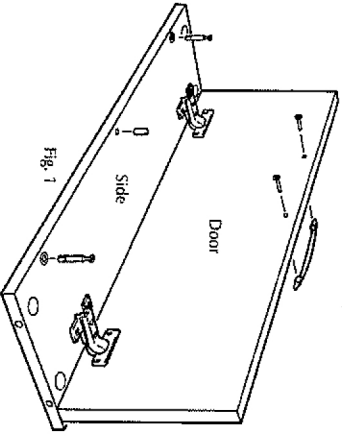

STAGE 2

ITEMS REQUIRED: Back panel / 2 side panels (1 with door) / 2 dowels / 4 locking screws / 4 locking nuts

Screw the 4 locking screws into the white plastic inserts in the side panels and push the dowels into the central holes (see Fig. 1).

Line the screws up with the holes on the side of the back panel ensure the locking nut holes on the back panel are on the back side and push the side panels onto the back panel. (the back panel can go either way up so you just need to decide which side you would like the holes for the electrics to be, left or right).

Push the locking nuts into the holes on the back side of the back panel, make sure the arrow on the locking nuts is pointing at the side panel. Use a cross-headed screwdriver to tighten the locking nuts (turn clockwise).

