



Tri-Spec[®]

High Output LED lighting

Instruction manual
and set up guide

LIFE SUPPORT
FOR COLDWATER OR TROPICAL AQUARIUMS

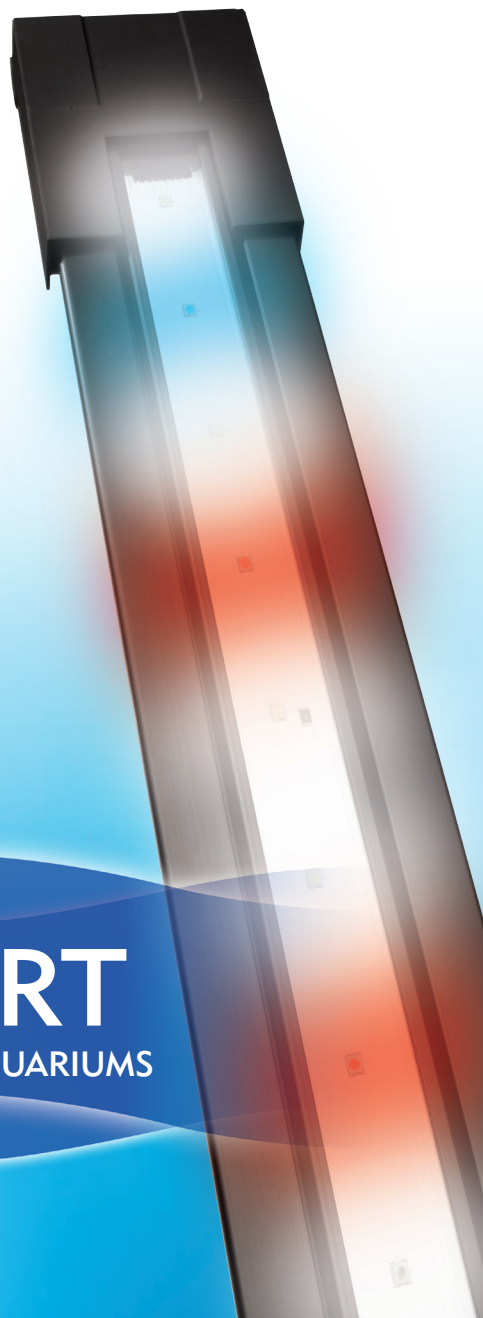

Getting to know your Tri-Spec lighting

Part No.	Description	Qty	Spare code
1	Adjustable end brackets	2	51559
2	Adjustment screws	4	
3	Retro fit metal brackets	2	51560
4	Retro fit screws	2	
5	Aluminium heat sink	1	n/a
6	Silicone glue finish	1	n/a
7	Power cable	1	n/a
8	LED light switch unit	1	n/a
n/a	Smart App controller (sold separately)	n/a	51557
n/a	Suspension kit (sold separately)	n/a	51558
9	Power supply transformer	1	n/a
10	Plastic spacers	n/a	51561

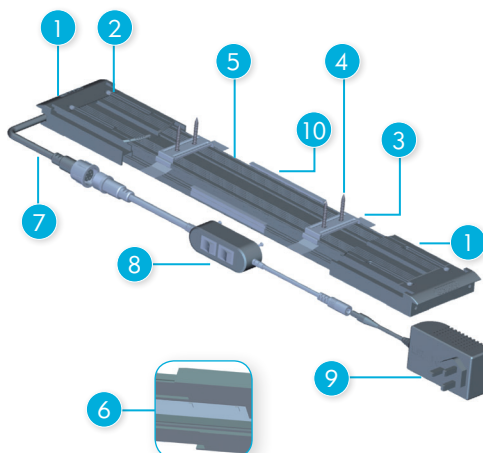

How to install your Tri-Spec HO LED lighting

1. The power supply transformer (9) is not waterproof – this must be mounted such that it cannot fall into the aquarium or be splashed by water. The cable must be installed with a drip loop to prevent any water running down the cable into the plug socket.
2. There is three options for fitting the Tri-Spec HO LED lighting unit;

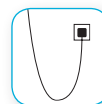

Direct replacement fit with adjustable end brackets

- a. If not already fitted, push fit the adjustable end brackets (1) onto both ends of the Tri Spec lighting bar, see illustration on pack. Ensure cable exits out of cable tunnel as seen on line drawing below and then down to the back of the aquarium.
- b. Loosen the 4 location screws (2), place the lighting bar in position in the aquarium and slide end brackets (1) so that the bracket lips fit securely on the aquarium edges then tighten all 4 screws. If you have them insert the aquarium flap covers in the slot on the end of the bracket (see diagram 2 to the right).
- c. Then lift the aquarium flap covers to the open position and install the plastic spacers (12) evenly along the LED aluminium lip, this is to ensure the aquarium flap covers are completely level when the aquarium flaps are in the closed position.

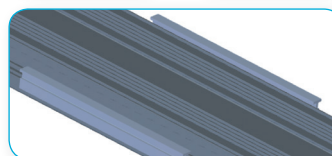
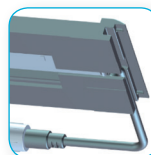

Top tip...if the Tri-Spec HO LED lighting unit is replacing a T8 unit not a Juwel style T5 unit, it may be necessary to create a new set of aquarium flap covers to fit correctly. Contact Interpet CustomerCare for further information.



Under Hood location with retro fit brackets

- Remove adjustable end brackets as these are not required.
- Ensure the hood material is thicker than the length of the retrofit screws (4) to prevent them protruding through the outer surface.
- Attach the retro fit brackets (3) lift both end tabs whilst push fitting the bracket firmly onto the aluminium heat sink (5). See diagram below.
- Place the Tri-Spec HO system in the desired location under the hood and draw around the retro fit brackets (3) with a pencil to indicate their position.
- Remove the brackets and place them in the pencil marked position in the hood. Using the self-tapping screws provided fix the bracket in position using the fixing holes in the bracket. When both brackets are fixed in position push fit the Tri-Spec lighting unit into the metal retro fit brackets.

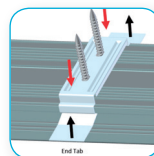

Top tip... If using retro fit screws is not possible, all-round plastic / metal glue could be used to attach the bracket instead, for example: 502 super adhesive glue. Always follow the glue manufacturer's instructions fully.

Above aquarium with suspension kit (Sold separately)

- This allows the Tri-Spec HO system to be suspended above an open top aquarium. Simply follow the installation guide included with the suspension kit.

Maintenance

Switch the Tri-Spec HO LED system off and carefully remove from the aquarium. Carefully wipe off any dirt or salt mineral deposits built up on the outside of silicone glue finish (6) with a damp cloth. Do not use cleaning agents that could enter the aquarium and harm your livestock.

Tri-Spec App Controller (sold separately)

The App controller allows for full light and timer customisation, simply swap the white and blue light controller for the App controller and download the free Tri-Spec HO App. Available for iOS & Android operating systems. For more information, contact Interpet CustomerCare for more information.

- This unit is for indoor use only – do not use outside.
- Do not use this unit if the cable or transformer plug are damaged or appear to be malfunctioning.
- Do not use this unit if the transformer plug gets wet.
- Dispose of responsibly following instructions from your local authority.

Replacement Tri-Spec HO transformers are also available as spares, see right for replacement codes;

Part No.	Description	Qty	Spare code
11	Tri-Spec HO Transformer 52-60	1	51563
11	Tri-Spec HO Transformer 69-80	1	51564
11	Tri-Spec HO Transformer 90-100	1	51565
11	Tri-Spec HO Transformer 116-124	1	51566
11	Tri-Spec HO Transformer 150	1	51567



Guarantee

This product is guaranteed against defects in Material and workmanship for 3 years from the date of purchase, under normal usage.

The GUARANTEE DOES NOT APPLY in case of improper use, negligence, lack of maintenance or accidental damage. If the LED fails due to a manufacturing fault within this period it will either be replaced free of charge or repaired. Liability is limited to replacement of the faulty product only no other costs will be reimbursed.

This guarantee is not transferable and does not affect your statutory rights. This guarantee does not confer any rights other than those expressly set out above.



Scan the QR code with your smart phone or tablet to visit our website and learn more about setting up your aquarium and fishkeeping.



 Scan the QR code with your smart phone or tablet to visit and LIKE our Facebook page.

You can help protect the environment. Please remember to respect the local regulations: hand in non-working electrical equipment to an appropriate waste disposal centre.

Consumer Advice contact details

Interpet Ltd.
Consumer Advice Department
Vincent Lane, Dorking, Surrey RH4 3YX
Fax: 01306 876712
E-mail: customercare@interpet.co.uk

