



Internal cartridge filter

CF MINI, CF1,
CF2 and CF3

Instruction manual
and set up guide



LIFE SUPPORT

HIGH QUALITY PRODUCTS, ESSENTIAL FOR
THE LONG-TERM HEALTH AND WELLBEING
OF YOUR AQUARIUM PLANTS AND FISH

Interpet 

Internal cartridge filter

Thank you for purchasing this Interpet **Internal Cartridge Filter**. Interpet has applied over sixty years of aquatic experience to ensure every element of the design of this product has been carefully considered to ensure you enjoy aquarium keeping.

Please retain this manual for on-going care and future reference.

We are sure that this filter will enable you to fully enjoy the benefits of owning and looking after aquarium fish and plants.

The Internal Cartridge Filter is easy to use and keeps the aquarium water clear and healthy for your fish. Uniquely, the filter also contains Algaway spheres to prevent unsightly algae ruining your viewing enjoyment.

Contents

- Why do I need a filter in my aquarium?
- Getting to know your Internal Cartridge Filter
- Installing your new Internal Cartridge Filter
- Maintaining your filtration
- Trouble shooting
- Top tips
- Guarantee and safety information

Section 1 - Why do I need a filter in my aquarium?

Aquariums are a closed system and any waste or dirt produced by fish and plants remains in the water. A filter acts like a waste processing plant:

- Trapping dirt and removing dyes for crystal clear water
- Processing fish waste creating healthy water
- Removing algae food to prevent algae growth
- Circulating and aerating water to maximise oxygenation

Effective four stage filtration

- 1 **Biomedica** - creates healthy water by acting as a home for essential bacteria which remove toxic fish waste
- 2 **Mechanical floss** - Clears water by trapping fine waste
- 3 **Carbon** - Purifies water by removing dyes, toxins, heavy metals and odours
- 4 **Algaway spheres** - Reduce unsightly algae by removing phosphate, algae's favourite food
- 5 **Oxygenated** - clear and healthy water returns to the aquarium



The nitrogen cycle

Before adding fish to your aquarium there is some important information to understand about how the aquarium water remains clean and healthy enough for fish to thrive.

The aquarium is a small 'closed' environment; this means harmful waste can build up quickly because there is not enough water volume to dilute the waste, as would happen in a natural lake, nor is there a constant supply of fresh water to wash it away, as would happen in a river or stream. The breakdown of fish waste, excess food, dead plant material and other organic matter will cause invisible toxic compounds to build up in the aquarium water, unchecked this would eventually harm your fish. Fortunately there is a natural process called the 'Nitrogen Cycle' which we can recreate in the aquarium to convert the toxic waste into safer compounds (The diagram below shows how this process works).

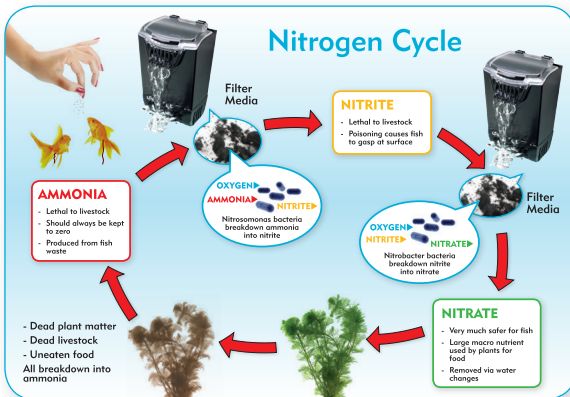

This Nitrogen Cycle is carried out by essential 'Nitrifying' bacteria which set up home in the biological media in the aquarium filter. These bacteria would naturally take a couple of months to become established in the filter. During this maturing period fish keepers often experience fish losses caused by the build-up of invisible toxic compounds which is referred to as 'New Tank Syndrome'.

New Tank Syndrome can be avoided by; adding Quick Safe Start to boost beneficial bacteria levels, and with correct water care.

Section 2 - Getting to know your Internal Cartridge Filter

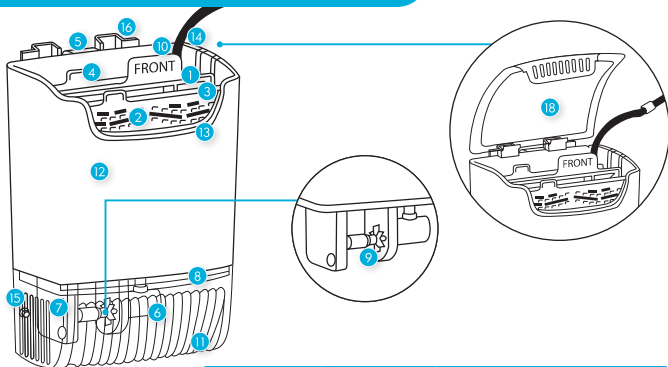

Part No.	Part Description	Spares Code			
		CF MINI	CF1	CF2	CF3
1	Fine Filter Cartridge (In Service Pack)	1 Month: 2315 3 Month: 2316	1 Month: 2317 3 Month: 2318	1 Month: 2319 3 Month: 2320	1 Month: 2321 3 Month: 2322
2	Algaway Pad Bio Holster	N/A	2334	2335	2336
3	Algaway Pad (In Service Pack)	N/A	1 Month: 2317 3 Month: 2318	1 Month: 2319 3 Month: 2320	1 Month: 2321 3 Month: 2322
4	Ceramic Media Cartridge	–	–	–	–
5	Locator Hook	–	–	–	–
6	Pump Inlet Cover and Pipe	–	–	–	–
7	Pump Motor	3526	2326	2327	2328
8	Pump Plate Locator	–	–	–	–
9	Pump Impellor	2325	36635	36636	2314
10	Pump Cable Duct	–	–	–	–
11	Removable Intake Cage	3527	2337	2338	2339
12	Filter Body	–	–	–	–
13	Water Return Cascade	–	–	–	–
14	Pump Cable	–	–	–	–
15	Rubber Vibration Dampers	–	–	–	–
16	Sucker Mounted Location Cradle	N/A	2323		2324
17	Attachment Suckers	2330	2330	2330	2347
18	Clear Filter Cover	3528	3529	3530	3531

Specification Chart

Size	Max Flow Rate		Power	For Aquarium Size	
	Lt/hr	Gal/hr		Length	Volume
CF	Lt/hr	Gal/hr	Watts	cm (inch)	Litres (gal)
MINI	130	28.5	3.5	Up to 40 (16)	12-35 (2.6-8)
1	320	70	3.3	Up to 60 (24)	36-68 (8-15)
2	480	106	4	Up to 80 (28)	68-110 (15-24)
3	700	153	10.5	Up to 100 (40)	111-160 (20-35)

Section 3 - Installing your new Internal Cartridge Filter

Unpack all of the items in the box and check everything is present against the parts list in section 2.

Your Internal Cartridge Filter is set up ready for use. For the CF1, CF2 & CF3 simply fix the sucker mounted support cradle (16) onto the back or side of your aquarium, and then slide the filter into place using the locator hook (5). For the CF Mini, suckers are conveniently located on the back of the filter body enabling direct fit onto the inside of the aquarium glass. It is advisable to position the filter where it is easy to reach for cleaning. The support cradle enables your cartridge filter to hook into position as seen in the below diagrams;

Position cradle on aquarium

For the CF1, CF2 & CF3 push firmly on the location cradle to the side or back wall of the aquarium, ensure it is as high it can go but allowing space for the locator hook to attach. See diagram right.

Note: This may need to be adjusted, to achieve the correct water level or ensure that the filter does not interfere with the aquarium hood.

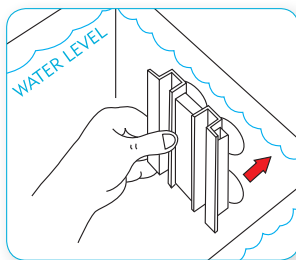

Attach cartridge locator hook

Now attach the cartridge locator hook (5) by push fitting onto the two location pins on the back of the main filter body (12). The hook has a number of locator holes to allow the filter height to be adjusted to achieve the correct filter water level position in different aquarium designs.

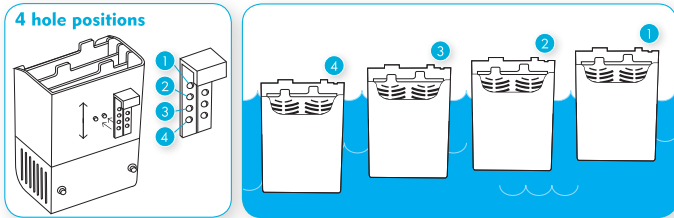

Note: The higher up the hook for example position 1 the higher up the cartridge filter will sit on the location cradle (16) and thus in the aquarium.

The CF Mini also comes complete with a cartridge locator hook which can be used to hang directly on the top edge of the aquarium. When using this direct installation remove the bottom two suckers and replace with the supplied vibration dampers (15). This minimises vibration noise when the filter is in operation.

Attach Internal Cartridge Filter

Then hook the cartridge filter onto the top of the location cradle (16) as seen in diagram (a) below, the water level should be no higher than the maximum line on the front of the cartridge body (12) as seen in figure (b) below.

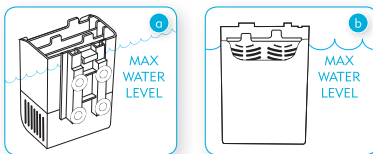

Important safety information

To prevent any drips entering the electrical socket, create a drip loop for the filter cable as per the diagram to the right.

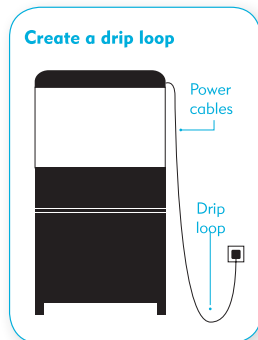

Section 4 - Maintaining your filtration

Always turn off power to your filter when carrying out maintenance. The cartridge filters are designed so that the replacement cartridges (1) & (2) can be easily removed. Simply lift the clear filter cover (18) to the fully open position and pull out each cartridge vertically using the appropriate tab and dispose of the old cartridge and Algaway pad (if included), replace with new ones using the service packs (sold separately).

Note the CF Mini cartridge has only one cartridge which comes complete with the Algaway spheres inside the cartridge, not in the separate pad format as supplied with the CF1, CF2 & CF3.

Daily Care Routine

- Ensure the filter is working and that there is good water flow to oxygenate the water. This is good for both fish and the bacteria in the filter.

Weekly Care Routine

- Top up any water evaporation to ensure the filter works most effectively.

Monthly Maintenance Routine

- Lift the clear filter cover to the fully open position above the filter (as per image 1 below).
Remove and discard the old filter cartridge (2), replace with a new cartridge, - ensure the cartridge is fully inserted the right way round ('FRONT' on tab facing forwards) in the correct slot in the filter body. See image 2 below.
- For the CF1, CF2 & CF3, remove the holster from the filter (2) and slide out the old Algaway pad (3) and discard. Insert the new Algaway pad into the holster and reinsert into the filter body. See image 3 below.

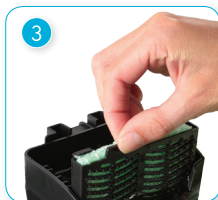

Three Monthly Care Routine

- Turn off power to the cartridge filter and remove cartridge filter from the aquarium. Then unclip the intake cage (11) and clean in fresh water, be sure to remove as much plant matter and substrate as possible from around the intake grills otherwise it may start to impact the flow rate of the pump.
- Then remove the impeller cover (6) and impeller (9) from the pump motor (7). Clean the impeller and the inside of the motor with water and a small brush. Then reverse this process to reassemble and install back into the aquarium.

Annual Maintenance Routine

- Once a year the impeller (9) will need to be replaced, follow the monthly impeller maintenance as above and insert a new impeller into the impeller chamber. Replacement impellers are available from your local aquatic retailer under code: 2325 for the CF Mini, 36635 for the CF1, 36636 for the CF2 and 2314 for the CF3 cartridge filter.

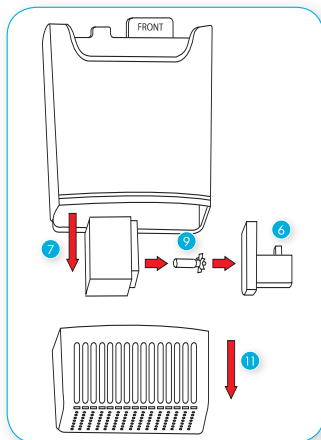

Section 5 - Troubleshooting

Problem 1: Filter flow rate drops considerably

Solution 1: Check for dirt and debris around the clip on intake cage (11) and the inlet pipe (6) and remove. If this does not resolve the flow rate problem, check the impellor (see problem 2).

Solution 2: The cartridge filter design is specifically built around easy access to replace the filter cartridges, this means the outflow is powered by gravity which can appear to be slower than other internal power filters. In reality the CF filter range delivers the same if not more flow than conventional internal power filters but the way its returned via the water return cascade (13) can appear less but works just as effective in filtration.

Problem 2: Filter is noisy

Solution 1: The impeller (9) should be removed and carefully cleaned, see three monthly care routine. Once the impeller has been cleaned it should be inspected for any damage. If the impeller or magnet is damaged in any way, the impeller should be replaced.

Solution 2: The CF Mini also comes complete with a cartridge locator hook (5) which can be used to hang the filter directly on to the top edge of the aquarium. When using this direct installation, remove the bottom two suckers (17) and replace with the supplied vibration dampers (15). This minimises vibration noise when the filter is in operation.

Problem 3: Power cut

Solution: Any interruption of more than 2-3 hours of the water supply through the filter will cause the bacteria in the filter to die. Should this occur, do not simply re-start the filter. You must thoroughly clean ALL the filter material and start the filter again. In an aquarium fully stocked with fish, this may lead to water quality problems. Use test kits to monitor water, Ammonia Remover & Quick Safe Start products to manage the water quality.

Problem 4: Water will not stay crystal clear

Solution 1: If the aquarium does not contain large, messy fish check to ensure the cartridge filter is working correctly, inspect the white polymer wool cartridge (1) to see it is correctly positioned in the key locator and also if it was replaced within 28 days (if not it must be replaced).

Solution 2: Additionally you may consider using Interpet Quick Clear which clumps together the fine particles and allows them to be removed more effectively by the filter. Additionally cut down on feeding levels for two to three days and ensure you perform monthly water changes.

Problem 5: Filter flow runs over the top of the filter cartridge prematurely

Solution 1: The cartridge filter must be positioned in the aquarium no higher than the 'Max water line' located on the front of the filter body (12), see section 3. This ensures sufficient head height for water flow to pass through a new filter cartridge (1) before it becomes blocked by dirt and debris over the specified 28 day filtration period.

Solution 2: (Solution 1 from problem 4)

Section 6 - Top tips for a beautiful and healthy aquarium

1. Select the correct amount and correct species of fish for a balanced and calm community.
2. Care for your water; do all the recommended water changes, filter cleaning, tests and feed correctly, taking special care in the early days or when adding new fish.
3. Don't rush the early days, start slowly and carefully for long term success.
4. ENJOY YOUR AQUARIUM!

See online for further information on all aspects of keeping an aquarium and fishkeeping or join others in our Facebook community: www.facebook.com/interpet

Guarantee

This product is guaranteed as free from defects in materials and workmanship for a period of 12 months from the date of purchase. The guarantee covers only any defects caused during normal use and operation of the filter, in accordance with the instructions enclosed.

It does not apply to any unauthorised modifications or misuse, improper or inadequate maintenance, or operations outside the product specifications. In case of defect within the stated warranty period, the product should be returned, with proof of purchase, to the point of purchase.

This guarantee does not effect your statutory rights. Guarantee service includes repair or replacement of the filter at Interpet Ltd.'s discretion. Neither Interpet nor the manufacturer are liable for any direct, indirect, special, incidental or consequential damages, including loss of livestock, arising from a defect in this product.

Important Safety Information

WARNING: To guard against injury, basic safety precautions should be observed, including the following guidelines.

READ AND FOLLOW ALL SAFETY INSTRUCTIONS

DANGER: To avoid possible electric shock, special care should be taken since water is employed in the use of aquarium equipment. For each of the following situations, do not attempt repairs yourself, return the appliance to an authorized service facility for service, or discard the appliance.

This is for indoor use only – do not use outside. Do not use this unit if the cable or plug are damaged or appear to be malfunctioning, or if it is dropped or damaged in any manner. Do not use this unit if the plug gets wet. Refer to section 2 of this instruction manual to find out how to create a drip loop for the filter. Dispose of responsibly following instructions from your local authority. Close supervision is necessary when any appliance is used by or near children. Do not install or store the appliance where it will be exposed to the weather or to temperatures below freezing point. If an extension cord is necessary, a cable rated with a proper rating should be used. A cable rated for less amperes or watts than the appliance rating may cause the appliance to overheat. Care should be taken to arrange the cable so that it will not be tripped over or pulled.

SAVE THESE INSTRUCTIONS

Disposal of used Electrical & Electronic Equipment (Applicable in the European Union and other European countries with separate collection systems)
The symbol on the product or on its packaging indicates that the product must not be disposed of with normal household waste. Instead, it is your responsibility to dispose of your waste equipment by arranging to return it to a designated collection point for the recycling of waste electrical and electronic equipment. By separating and recycling your waste equipment at the time of disposal you will help to conserve natural resources and ensure that the equipment is recycled in a manner that protects human health and the environment. For more information about recycling this product, please contact your local city office, your household waste disposal service or the shop where you have purchased the product.



Service Packs

One and three month service packs available for your Internal Cartridge Filter.



Bioactive Tapsafe Plus

A unique and advanced formulation developed in conjunction with global leaders in Biotechnology. It removes chlorine, chloramines and heavy metals and this in turn allows even hot tap water to be used as part of a water change mix. An Aloe Vera protective colloid within Tapsafe creates a barrier around the fish's delicate skin and gill membranes. As an added feature it also adds a culture of bacteria and enzymes that consume any excess biological waste in the aquarium and boosts filter performance.



Easy Test Health Tablet Test Kit

Complete with tablet tests for ammonia, nitrite, nitrate and broad range pH, along with 2 plastic test vials and a tablet crusher. It also includes the colour instruction booklet which gives accurate advice on how to use this easy kit along with recommendations on the test results. An effective and simple way for you to test your aquarium water, ideal for new aquarium set-ups.



Interpet has applied over 60 years of aquatic experience to ensure every element of the design of this product has been carefully considered to help you enjoy aquarium keeping.

e-mail: customercare@interpet.co.uk
Interpet Ltd. Vincent Lane, Dorking, Surrey
RH4 3YX, England
[facebook.com/interpet](https://www.facebook.com/interpet)
www.interpetaquatics.co.uk